

AXIOM TRANSITIONS

Extruded aluminium sections to provide a seamless transition between plasterboard margins and suspended ceilings

Key Attributes

- 12 sections designed for compatibility with different edge details using Axiom universal accessories for secure and easy installation
- Compatible with Armstrong exposed ceiling grid systems including Silhouette and Interlude HRC designer grids
- Plasterboard jointing flange for seamless integration with plasterboard ceilings and Armstrong Drywall Grid System

Application area

All ceilings - Perimeters

Physical data

- Material: aluminium
- Surface finish: polyester powder painted
- Colour: Global White / RAL 9010
- Other colours available upon request

PRODUCT RANGE

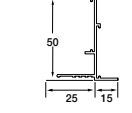
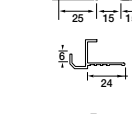
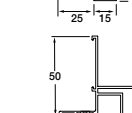
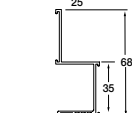
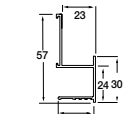
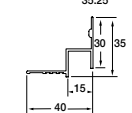
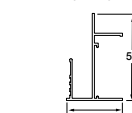
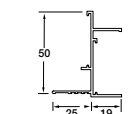
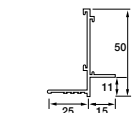
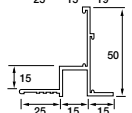
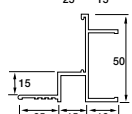
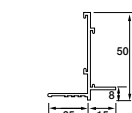

Item Nr.	Designation	Dimensions		Content / Carton		Weight / Carton kg	Cartons / Pallet
		length (mm)	height (mm)	pcs	lm		
T 3208 G ⁽¹⁾	AXIOM Transitions for Tegular/MicroLook	3000	50	10	30.00	11.80	36
T 3219 G ⁽¹⁾	AXIOM Transitions channel	3000	50	10	30.00	17.10	36
T 3215 G ⁽¹⁾	Axiom Transitions shadowline angle	3000	50	10	30.00	15.00	36
T 3210 G ⁽¹⁾	AXIOM Transitions for Vector tiles	3000	50	10	30.00	11.80	36
T 3228 ⁽¹⁾	Axiom Transitions shadowline channel	3000	50	10	30.00	13.50	36
T 3230 ⁽¹⁾	AXIOM Transitions upstand Channel 13mm Board	3000	53	10	30.00	13.80	36
T 3270 ⁽²⁾	AXIOM Transitions Shadowline for T-Clip F (full tiles)	3000	35	10	30.00	8.85	36
T 3272 ⁽²⁾	AXIOM Transitions channel for B-H 300 (full tiles)	3000	57	10	30.00	12.45	36
T 3273 ⁽²⁾	AXIOM Transitions angle with offset 25mm	3000	68	10	30.00	14.95	36
T 3276 ⁽²⁾	AXIOM Transitions Shadowline for B-H 300 (full tiles)	3000	51	10	30.00	19.65	36
T 3277 ⁽²⁾	AXIOM Transitions for S-Clip F, Q-Clip F, R-Clip F (full tiles)	3000	18	10	30.00	6.03	36
T 3271 ⁽¹⁾	AXIOM Transitions angle	3000	51	10	30.00	12.00	36

● SYSTEM DRAWING

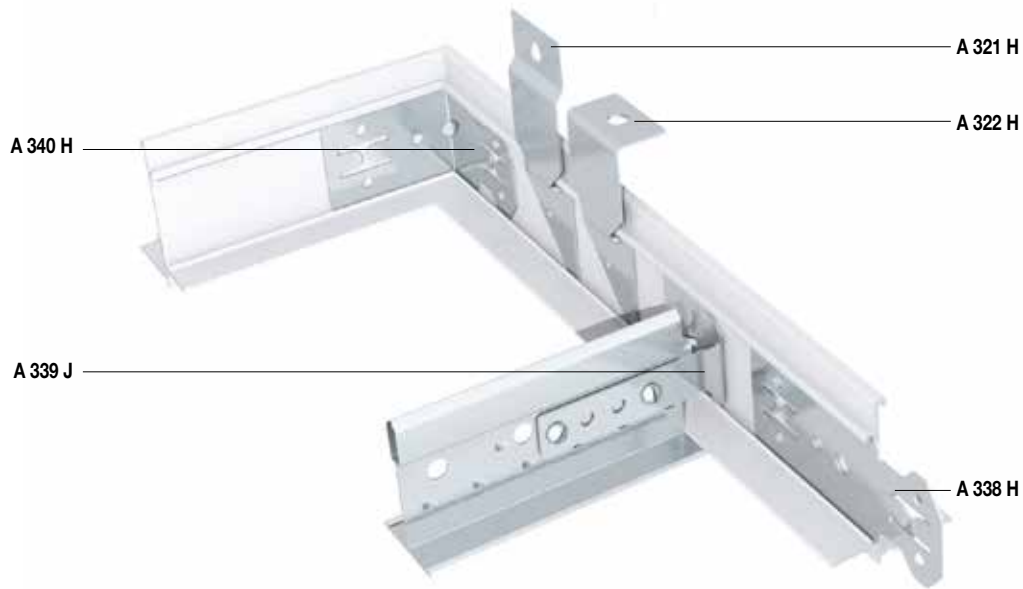

● CROSS SECTION

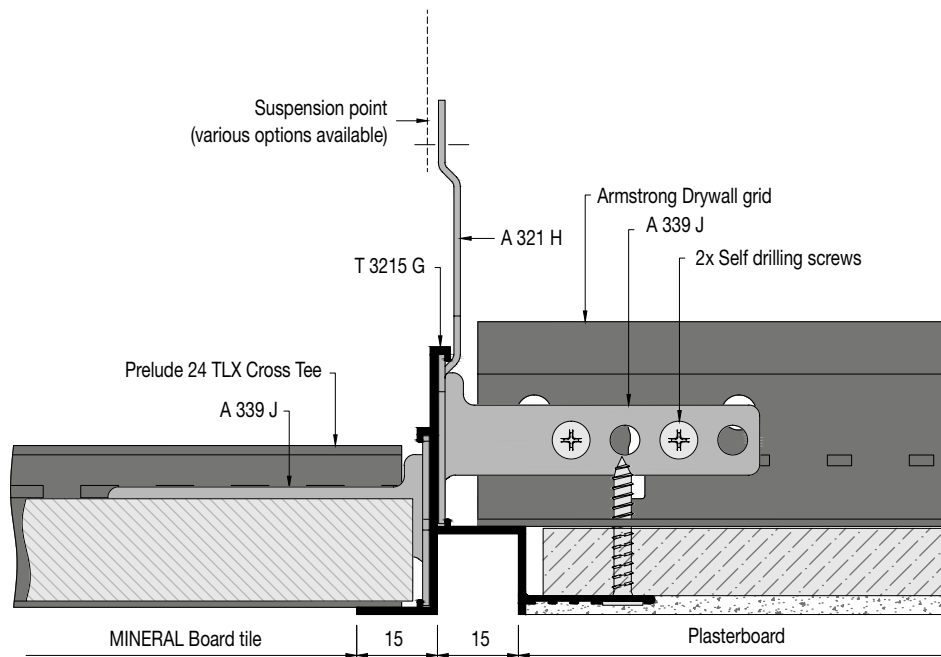

All canopies available in Global White. For any other colours, please contact Armstrong Technical Sales.
 (1) Also available in RAL 9010.
 (2) Standard colour RAL 9010 (WR), Global White on request.
 All measurements in millimeters. All sizes are nominal.
 Availability of products may vary according to location.
 Please contact Armstrong Technical Sales for further details.



www.armstrongceilings.co.uk

Armstrong[®]
 CEILING SOLUTIONS